

Compact Ultrasonic Anemometer

General purpose, easy to use, high performance wind sensor

WindUltra anemometers are supported by a range of accessories. These accessories can be used to connect, install and maintain WindUltra. The accessories have been designed, or selected, to ensure the long term performance of WindUltra products.

ACCESSORIES	
Connector, M12, 8 way, field wireable	1416-PK-002
Cable, power & communications cable, 2m with fitted M12 connector at WindUltra end	1416-PK-011
Cable, power & communications cable, 5m with fitted M12 connector at WindUltra end	1416-PK-012
Cable, power & communications cable, 10m with fitted M12 connector at WindUltra end	1416-PK-013
Cable, power & communications cable, 20m with fitted M12 connector at WindUltra end	1416-PK-014
Pole mount, 1 inch (25-26mm), black	1416-PK-021
Pole mount, 2 inches, (44-51mm), black	1416-PK-022
Pole mount adaptor kit	1416-PK-023
Cable, for WindUltra set-up, 0.8m, USB (Type A) to USB (Micro-USB)	1416-PK-031
WindSet software* to configure WindUltra WindView software*, to view reported parameters	* download from Gill Instruments website

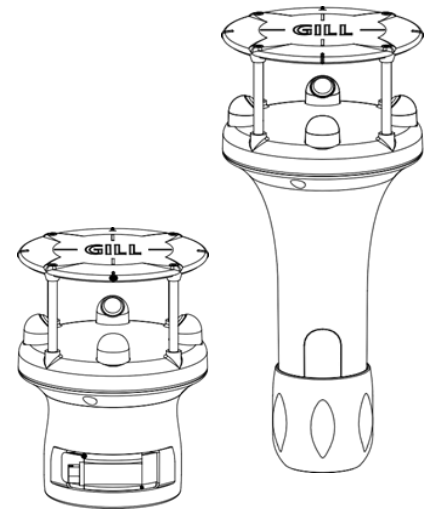

Accessory descriptions

• M12 field wireable connector (1416-PK-002)

The M12 connector has 8 pins and is field wireable (screw terminal). It is compatible with the connectors used on WindUltra for power and communications for operational use.

• Power & communications cables

The 4 pair cable can be used to connect WindUltra to power and communications for operational use.

A pre-made cable can be supplied in standard lengths with a single 8 pin M12 connector fitted on the WindUltra end. The cable can be cut to the required length and a connector to interface with the logging system can be fitted. The following options are available

- 2m cable wired with one M12 connector (1416-PK-011)
- 5m cable wired with one M12 connector (1416-PK-012)
- 10m cable wired with one M12 connector (1416-PK-013)
- 20m cable wired with one M12 connector (1416-PK-014)

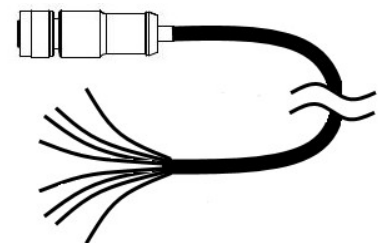

Compact Ultrasonic Anemometer

General purpose, easy to use, high performance wind sensor

- **Pole mount, 1 inch (25-26mm) (1416-PK-021)**

The 1 inch (25-26mm) pole mount enables a WindUltra sensor to be mounted on a pole with external diameter 25-26mm. The pole mount is constructed from black poly-carbonate. Details of how to install and align the pole mount can be found in the WindUltra User Manual which can be downloaded from gillinstruments.com.

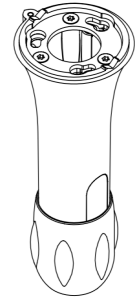

- **Pole mount 2 inch (44-51mm) (1416-PK-022)**

The 2 inch (44-51mm) pole mount enables a WindUltra sensor to be mounted on a pole with external diameter 44-51mm. The pole mount is constructed from black poly-carbonate. Details of how to install and align the pole mount can be found in the WindUltra User Manual which can be downloaded from gillinstruments.com.

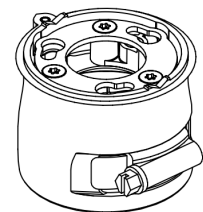

- **Pole mount adaptor kit (1416-PK-023)**

The Pole Mount Adaptor Kit has been designed to allow a 1 inch (25-26mm) pole to be attached to an existing structure. The metal adaptor kit can be fixed to a vertical surface or to an existing tube/ tower. A range of different configurations are shown on the next page. Note: The adaptor kit can be used with tubes with an external diameter or cross section of between 1-2 inches (44-51 mm), see next page for examples.

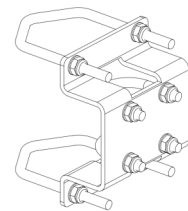

- **Cable for WindUltra set-up 0.8m (1416-PK-031)**

The USB (Type A) to USB (Micro-USB) cable provides power and communications from a PC to the WindUltra USB port to allow the sensor to be set-up. The cable is 0.8m long to ensure ease of use.

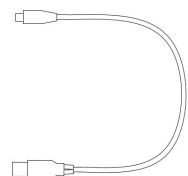

- **WindSet software**

WindSet is a Windows compatible software package that can be used to change the set-up of a WindUltra unit. WindSet is free to use and can be downloaded from gillinstruments.com.

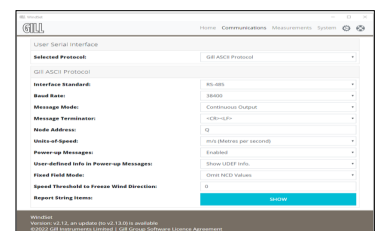

- **WindView software**

WindView is a Windows compatible software package that can be used to view and log the measurement data provided by WindUltra. WindView is free to use and can be downloaded from gillinstruments.com.

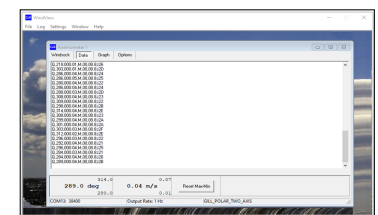

Compact Ultrasonic Anemometer

General purpose, easy to use, high performance wind sensor

Pole mount adaptor kit 1416-PK-023

The drawings below show different ways the pole mount adaptor kit can be used to secure a 1 inch (25-26mm) pole to an existing tube or surface.

